

Stationary concrete pump

BSA 14000 SHP D5

The machine for extreme applications
Output up to 72 m³/h

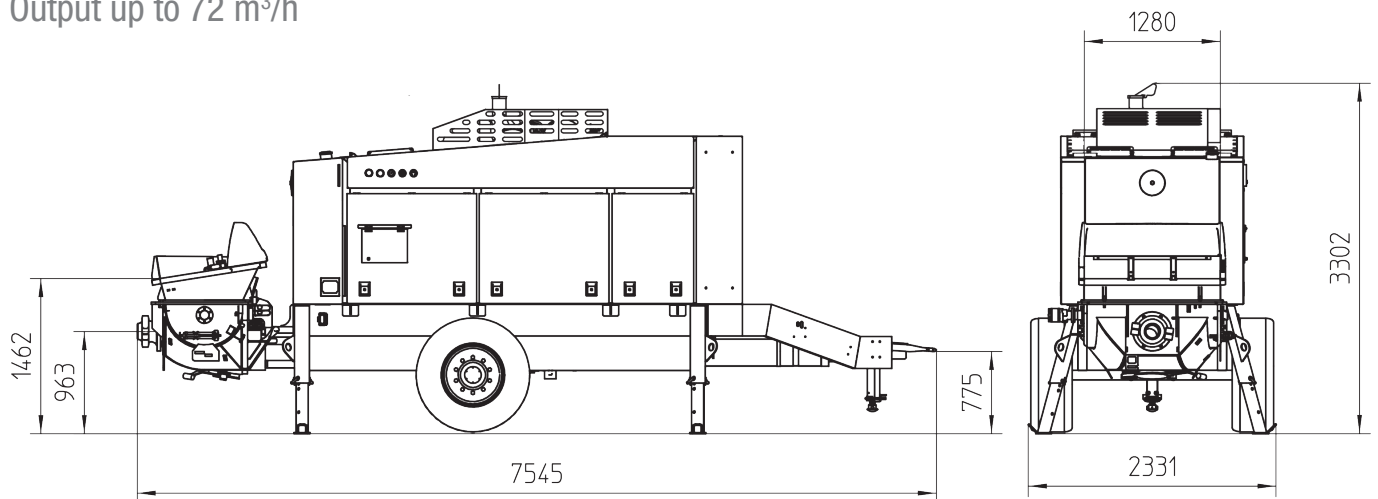

Note: Standard version. Dimensions and weights depend on equipment. Subject to technical modifications and errors.

Technical data

Model	BSA 14000 SHP D5	
Material number	102486.000	
Output	m ³ /h	72 / 37 *
Delivery pressure	bar	project specific +)
Delivery cylinder	Ø mm	180
Delivery cyl. stroke	mm	2100
Strokes / minute	22 / 11 *	
Engine	kW	470
Hopper	RS 905 SHP	
Capacity	l	approx. 600
Filling height	m	1.3
Transfer tube	S 1812 D	
Line connection	mm	ZX 125
Pressure connection	"	8
Control system	EPS FFH-20	
Weight	kg	13100

* Option, Values for hydraulic fluid being fed to piston-side

+) works setting 250 bar
All data max. theoretical

Serial equipment

Agitator safety switch off	Ergonic Graphic Display (EGD)
Balloon tyres incl. transport protection	Flushing water pump
Cable remote control 10 m	160 l/min 25 bar
Central lubrication on hopper, electrically	Gate valve connection
Cleaning accessories	Grill 60 mm
Coloring: Pump, frame, roof and tank anthracite grey; cover chrome yellow	Hard metal wear parts
Concrete hopper with agitator	Operating manuals (1× paper, 1× CD-ROM) spare part list
Concrete output adjust, electrically	Outriggers 4× mech.
Concrete pressure adjust, electrically	Pump flow meter
Coupling ring (DIN)	Set-up foot hydraulically
Drive diesel, CAT 470 kW (Option: 571 kW), Stage 5	Speed drawdown automatically on pump stop
Electronic error management	Splash guard
	Tool set incl. standard equipment
	Trailer F8, can be driven on job site

See quotation for exact serial delivery scope.
Comprehensive range of options available on request.